

Ma

KEY STAGE
3

TIER
3–5

2001

Mathematics test

Paper 1

Calculator not allowed

Please read this page, but do not open the booklet until your teacher tells you to start. Write your name and the name of your school in the spaces below. If you have been given a pupil number, write that also.

First name _____

Last name _____

School _____

Pupil number

--	--	--	--	--	--

Remember

- The test is 1 hour long.
- You **must not** use a calculator for any question in this test.
- You will need: pen, pencil, rubber, ruler, tracing paper and mirror (optional).
- This test starts with easier questions.
- Try to answer all the questions.
- Write all your answers and working on the test paper – do not use any rough paper.
- Check your work carefully.
- Ask your teacher if you are not sure what to do.

For marker's
use only

Total marks

--

Instructions

Answers



This means write down your answer or show your working and write down your answer.

Calculators



You **must not** use a calculator to answer any question in this test.

1. Look at this **multiplication** table.

x	11	12	13	14	15
21	231	252	273	294	315
22	242	264	286	308	330
23	253	276	299	322	345
24	264	288	312	336	360
25	275	300	325	350	375

(a) **Use the table** to fill in the gaps below.



$24 \times 13 = \dots\dots\dots$

.....
1 mark

$15 \times \dots\dots\dots = 330$

.....
1 mark

$288 \div 24 = \dots\dots\dots$

.....
1 mark

(b) Use the table to fill in the gaps.

Give two **different** pairs of numbers.



$\dots\dots\dots \times \dots\dots\dots = 264$

.....
1 mark

$\dots\dots\dots \times \dots\dots\dots = 264$

.....
1 mark



2. Look at these number cards.

600	60	6
400	40	4
300	30	3
100	10	1

- (a) Choose **two** of the cards that add together to give a **total** of **70**
Show the numbers on the cards below.



Now choose two **different** cards that add together to give a **total** of **70**



.....
1 mark

- (b) **Three** of the cards add together to give a **total** of **70**
Which three cards are they?



.....
1 mark

-
- (c) The **difference** between the numbers on two of the cards is **70**
Which two cards are they?



1 mark

- (d) Which two of the cards make this calculation correct?
Write the numbers on the cards below.

 × + = **70**

1 mark



3. (a) Work out



$$46 + 19 = \dots\dots\dots$$

1 mark

$$82 - 69 = \dots\dots\dots$$

1 mark

$$6 \times 6 = \dots\dots\dots$$

1 mark

$$28 \div 4 = \dots\dots\dots$$

1 mark

$$238 + 1487 = \dots\dots\dots$$

1 mark

$$723 - 154 = \dots\dots\dots$$

1 mark

(b) What number should you **add to 57** to make 100?



.....

1 mark

(c) What number should you **subtract from 100** to make 86?



.....

1 mark

4. Look at the diagram.

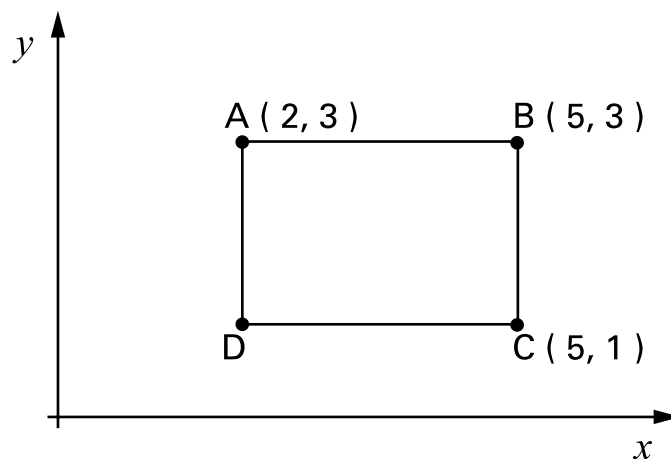

- (a) The point K is **halfway** between points B and C.
What are the coordinates of point K?

 (,)

.....
1 mark

- (b) Shape ABCD is a rectangle.
What are the coordinates of point D?

 (,)

.....
1 mark



5. The arrow by this thermometer shows a temperature of 20°C

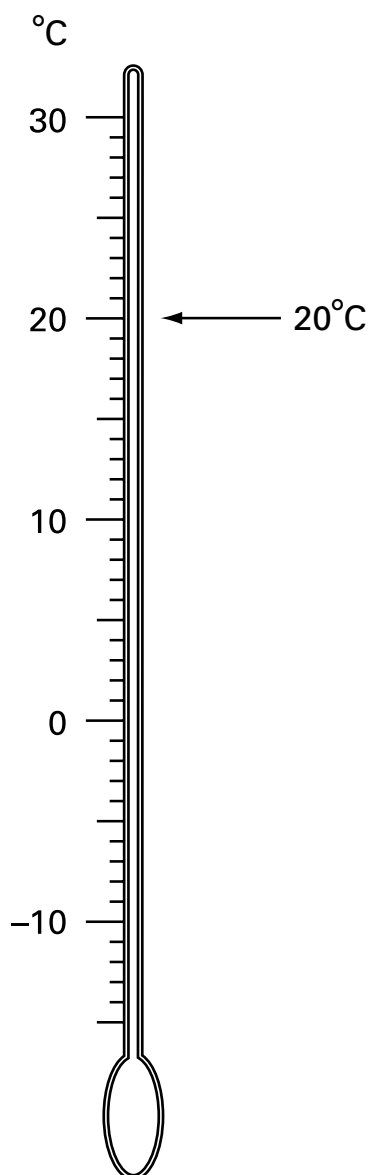

- (a) Draw an arrow by the thermometer to show 7°C

Label your arrow 7°C

.....
1 mark

- (b) Draw an arrow by the thermometer to show -5°C

Label your arrow -5°C

.....
1 mark

-
- (c) In New York the temperature was -2°C
In Atlanta the temperature was 7°C warmer.

What was the temperature in Atlanta?



.....
1 mark

- (d) In Amsterdam the temperature was 3°C
In Helsinki the temperature was -8°C

How many degrees warmer was it in Amsterdam than in Helsinki?



.....
1 mark



6. (a) Fill in the missing numbers.



$$25\frac{1}{2} + \dots = 27$$

.....
1 mark

$$150 - \dots = 27$$

.....
1 mark

$$50\% \text{ of } \dots = 27$$

.....
1 mark

$$\text{a quarter of } \dots = 27$$

.....
1 mark

(b) Write numbers in each space below to make the calculations correct.



$$\dots \times \dots = 27$$

.....
1 mark

$$\dots \div \dots = 27$$

.....
1 mark

7.

My clock shows:

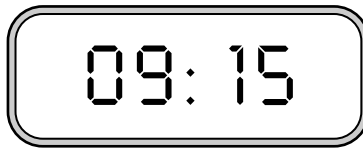

The hours and the minutes are both **multiples of 3**

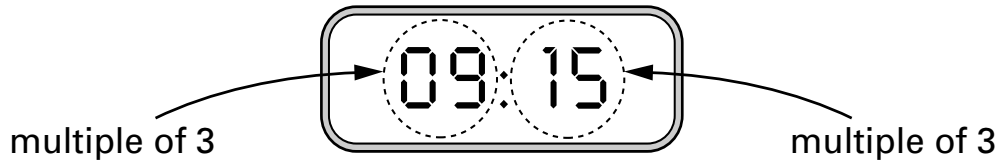

(a) Write a **different time** when the hours and the minutes are both multiples of 3

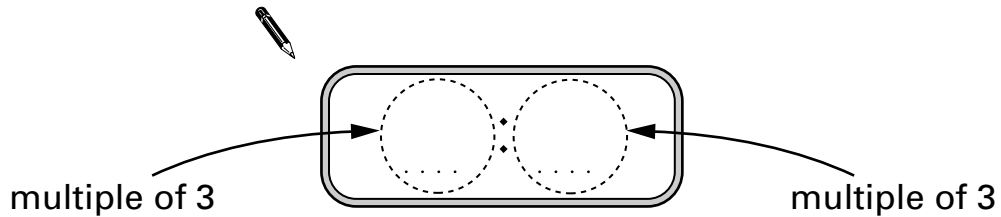

1 mark

(b) Later, my clock shows:

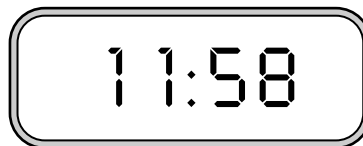

How many minutes will it be before the hours and the minutes are both **multiples of 6**?

 minutes

1 mark



8. (a) I start with a rectangle of paper.
I fold it in half, then I cut out three shapes.

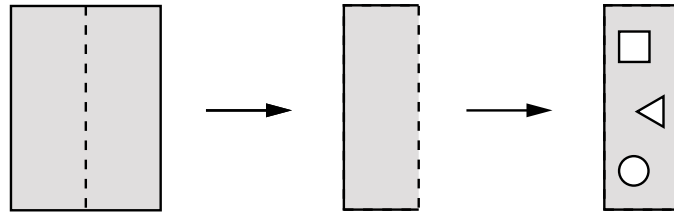

Then I unfold my paper.

Circle the diagram below that shows what my paper looks like now.

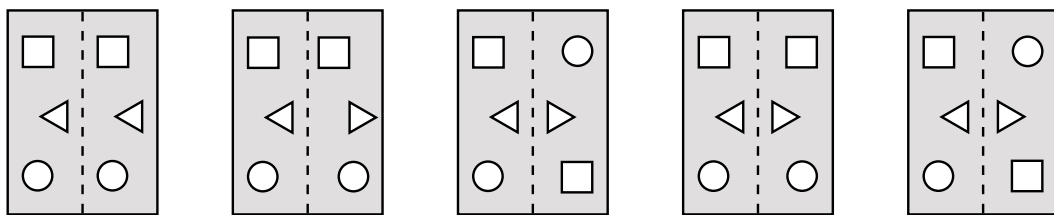

1 mark

- (b) I start again with a different rectangle of paper.
I fold it in half, then in half again, then I cut out two shapes.

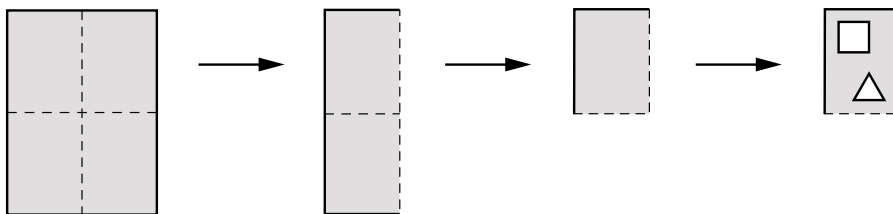

Then I unfold my paper.

Circle the diagram below that shows what my paper looks like now.

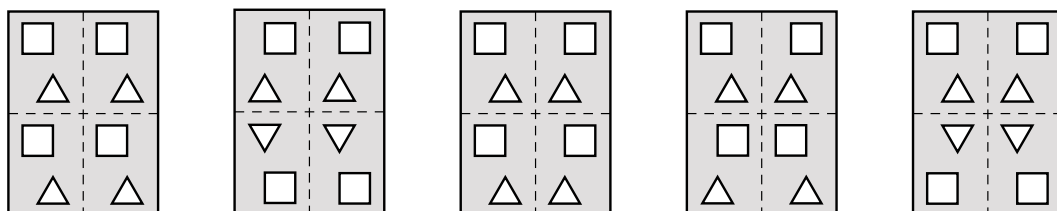

1 mark

(c) I start with a square of paper.

I fold it in half, then in half again, then I cut out one shape.

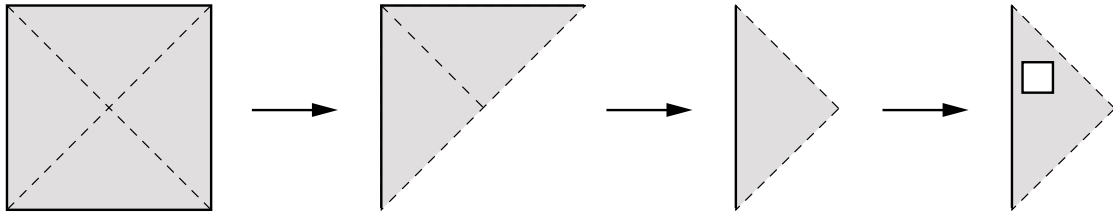

Then I unfold my paper.

Circle the diagram below that shows what my paper looks like now.

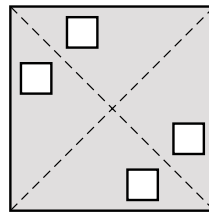
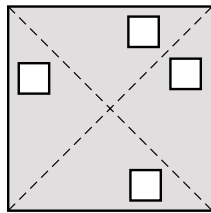
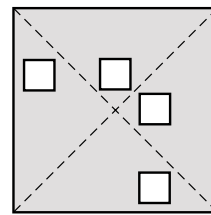
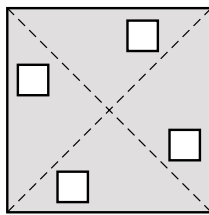
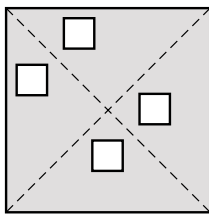

.....
1 mark



9. The diagram shows how many miles there are between junctions on a motorway.

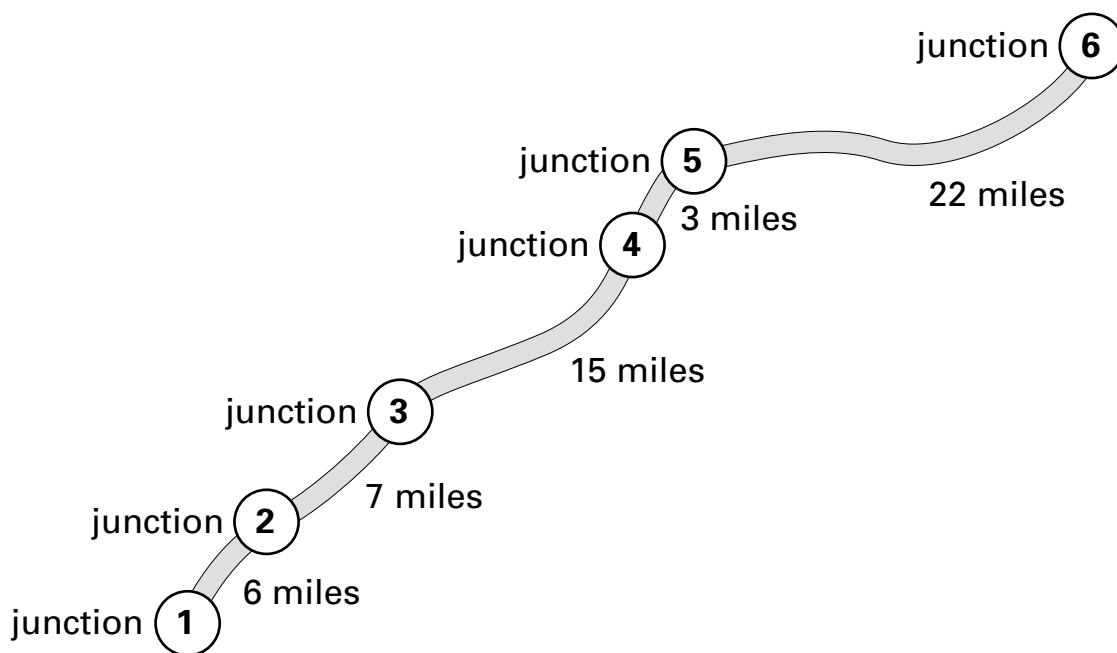

- (a) How many miles is it from junction 2 to junction 4?



..... miles

.....
1 mark

- (b) Which junction is 31 miles from junction 1?



.....

.....
1 mark

- (c) Mr Patel uses the motorway.

He drives from junction 2 to junction 3 and **back again** from junction 3 to junction 2

He does this **every day** for **five days**.

How many miles does he drive on the motorway altogether?



..... miles

.....
1 mark

10. (a) Write the answers.



$$(4 + 2) \times 3 = \dots\dots\dots$$

$$4 + (2 \times 3) = \dots\dots\dots$$

.....
1 mark

(b) Work out the answer to

$$(2 + 4) \times (6 + 3 + 1)$$



.....

.....
1 mark

(c) Put brackets in the calculation to make the answer **50**



$$4 + 5 + 1 \times 5$$

.....
1 mark

(d) Now put brackets in the calculation to make the answer **34**



$$4 + 5 + 1 \times 5$$

.....
1 mark



11. The diagram shows a box.

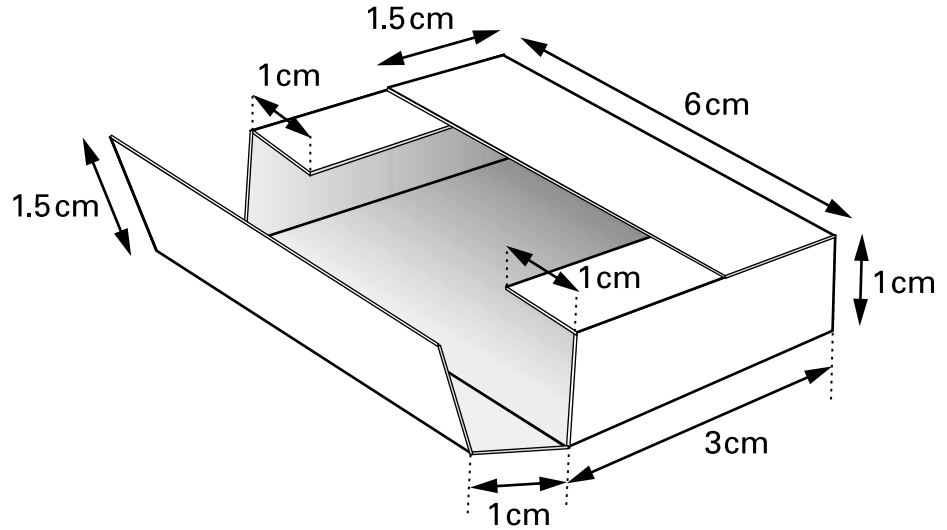

Complete the **net** for the box.

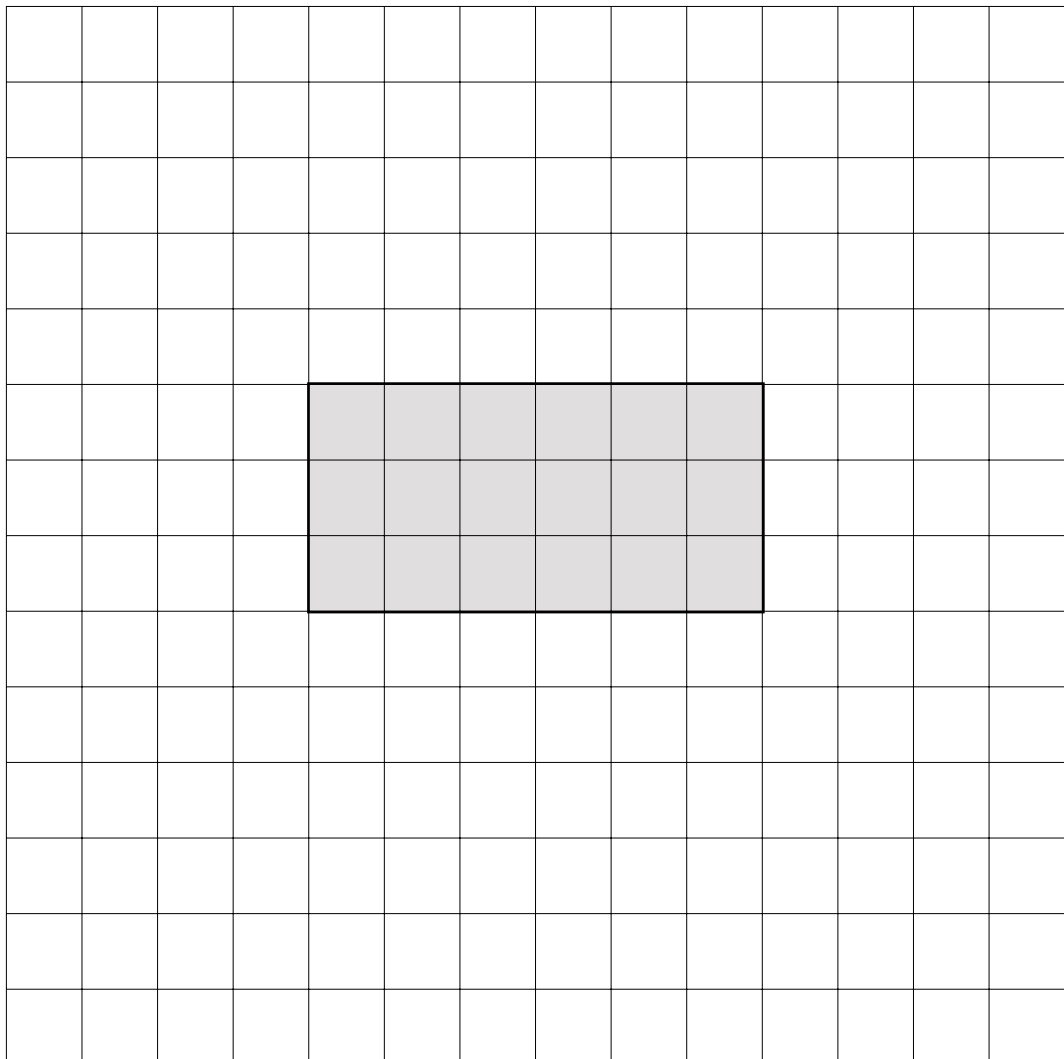

.....

 3 marks

12. (a) Look at these fractions.

$$\frac{1}{2}$$

$$\frac{1}{3}$$

$$\frac{5}{6}$$

Mark each fraction on the number line.

The first one is done for you.

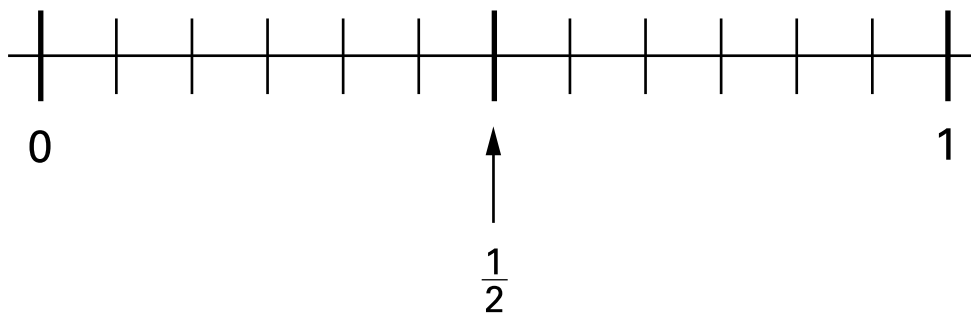

.....
1 mark

(b) Fill in the missing numbers in the boxes.



$$\frac{2}{12} = \frac{\square}{6}$$

$$\frac{1}{2} = \frac{12}{\square}$$

$$\frac{1}{\square} = \frac{6}{24}$$

.....

.....
2 marks



13. Mark and Kate each buy a family pack of crisps.
Each family pack contains **ten bags** of crisps.

The table shows how many bags of each flavour are in each family pack.

flavour	number of bags
plain	5
vinegar	2
chicken	2
cheese	1

- (a) Mark is going to take a bag of crisps at random from his family pack.
Complete these sentences.



The probability that the flavour will be is $\frac{1}{2}$
1 mark

The probability that the flavour will be **cheese** is
1 mark

- (b) Kate ate **two bags** of **plain** crisps from her family pack of 10 bags.
Now she is going to take a bag at random from the bags that are left.
What is the probability that the flavour will be **cheese**?



.....
1 mark

- (c) A shop sells **12 bags** of crisps in a large pack.
I am going to take a bag at random from the large pack.

The table below shows the probability of getting each flavour.

Use the probabilities to work out **how many bags** of each flavour are in this large pack.



flavour	probability	number of bags
plain	$\frac{7}{12}$	
vinegar	$\frac{1}{4}$	
chicken	$\frac{1}{6}$	
cheese	0	

.....
.....
2 marks



14. The diagrams show the number of hours of sunshine in two different months.

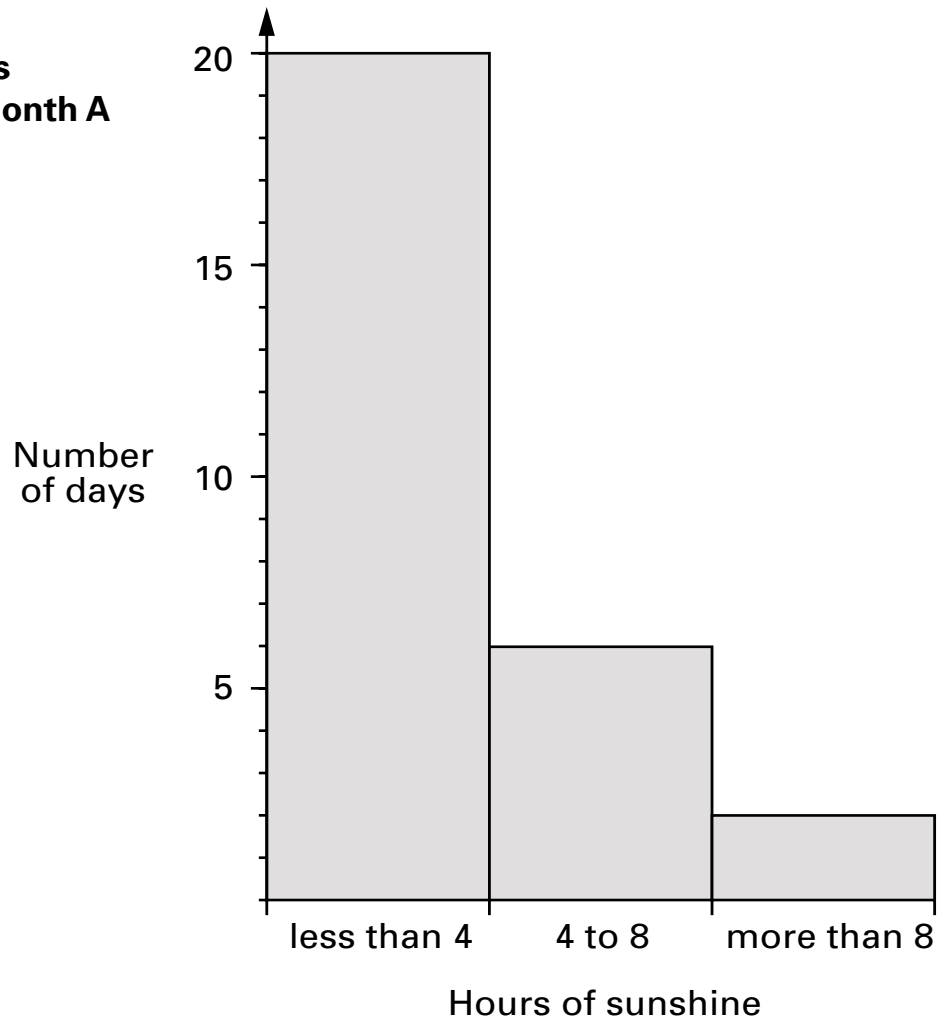

Number of hours of sunshine in month A

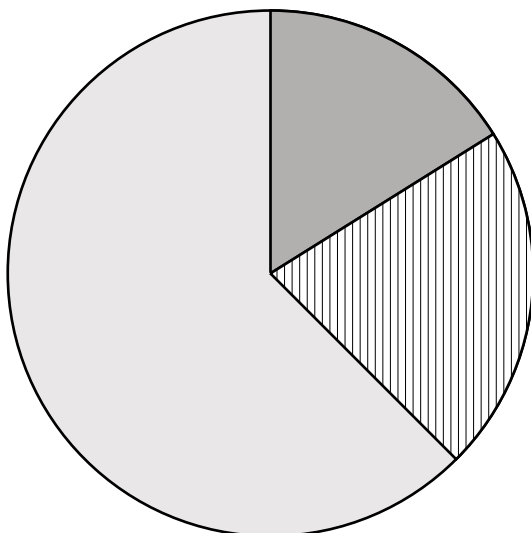

Number of hours of sunshine in month B



Key:

-  number of days with less than 4 hours
-  number of days with 4 to 8 hours
-  number of days with more than 8 hours

(a) How many days are there in **month A**?

Tick (✓) the correct box.



28

29

30

31

not possible
to tell

1 mark

(b) How many days are there in **month B**?

Tick (✓) the correct box.



28

29

30

31

not possible
to tell

1 mark

(c) Which month had more hours of sunshine?

Tick (✓) the correct box.



month A

month B

Explain how you know.



1 mark



15. (a) What **fraction** of this shape is shaded?
Write your fraction as simply as possible.



.....

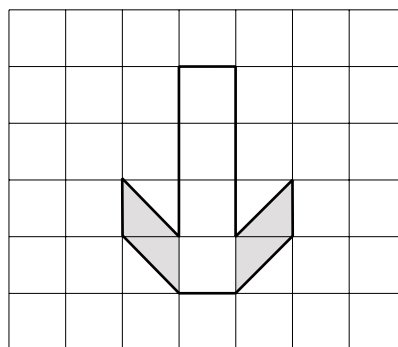

.....
1 mark

(b) What **percentage** of this shape is shaded?



..... %

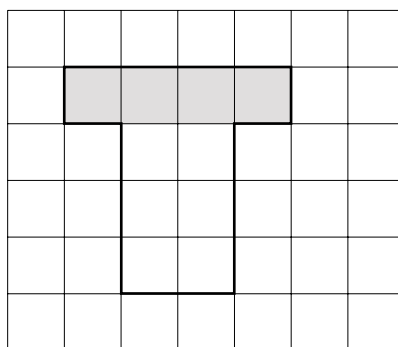

.....
1 mark

(c) Which shape has the **greater percentage** shaded?

Tick (✓) the correct box.



Shape A

Shape B

Both the same

Explain how you know.

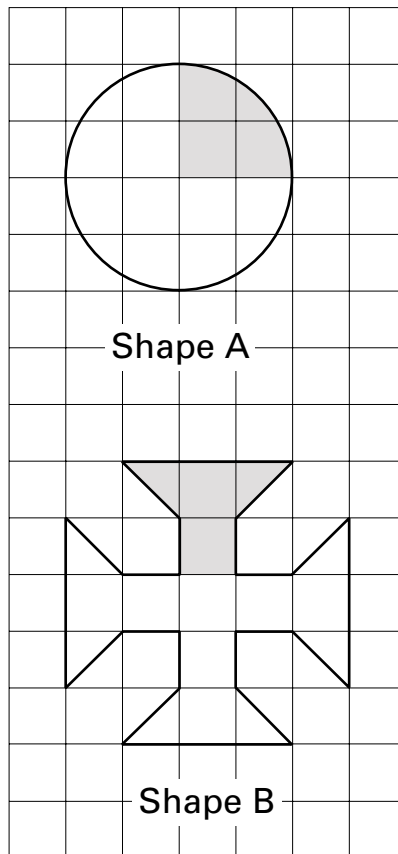

Shape A

Shape B

.....
1 mark

16. (a) A football club is planning a trip.

The club hires **234** coaches. Each coach holds **52** passengers.

How many passengers is that altogether?

Show your working.



.....
..... passengers
.....
2 marks

(b) The club wants to put one first aid kit into each of the 234 coaches.

These first aid kits are sold in **boxes of 18**

How many boxes does the club need?



..... boxes
.....
1 mark



